

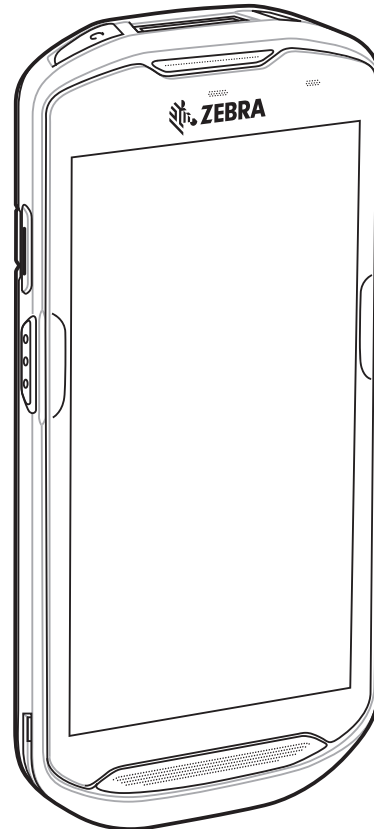

TC51



Touch Computer

Quick Start Guide



No part of this publication may be reproduced or used in any form, or by any electrical or mechanical means, without permission in writing. This includes electronic or mechanical means, such as photocopying, recording, or information storage and retrieval systems. The material in this manual is subject to change without notice.

The software is provided strictly on an “as is” basis. All software, including firmware, furnished to the user is on a licensed basis. We grant to the user a non-transferable and non-exclusive license to use each software or firmware program delivered hereunder (licensed program). Except as noted below, such license may not be assigned, sublicensed, or otherwise transferred by the user without prior written consent. No right to copy a licensed program in whole or in part is granted, except as permitted under copyright law. The user shall not modify, merge, or incorporate any form or portion of a licensed program with other program material, create a derivative work from a licensed program, or use a licensed program in a network without written permission. The user agrees to maintain copyright notice on the licensed programs delivered hereunder, and to include the same on any authorized copies it makes, in whole or in part. The user agrees not to decompile, disassemble, decode, or reverse engineer any licensed program delivered to the user or any portion thereof.

We reserve the right to make changes to any software or product to improve reliability, function, or design.

We do not assume any product liability arising out of, or in connection with, the application or use of any product, circuit, or application described herein.

No license is granted, either expressly or by implication, estoppel, or otherwise under any of our intellectual property rights. An implied license only exists for equipment, circuits, and subsystems contained in our products.

Warranty

For the complete Zebra hardware product warranty statement, go to: <http://www.zebra.com/warranty>.

Service Information

If you have a problem using the equipment, contact your facility's Technical or Systems Support. If there is a problem with the equipment, they will contact the Zebra Support at: <http://www.zebra.com/support>.

For the latest version of this guide go to: <http://www.zebra.com/support>.

Features

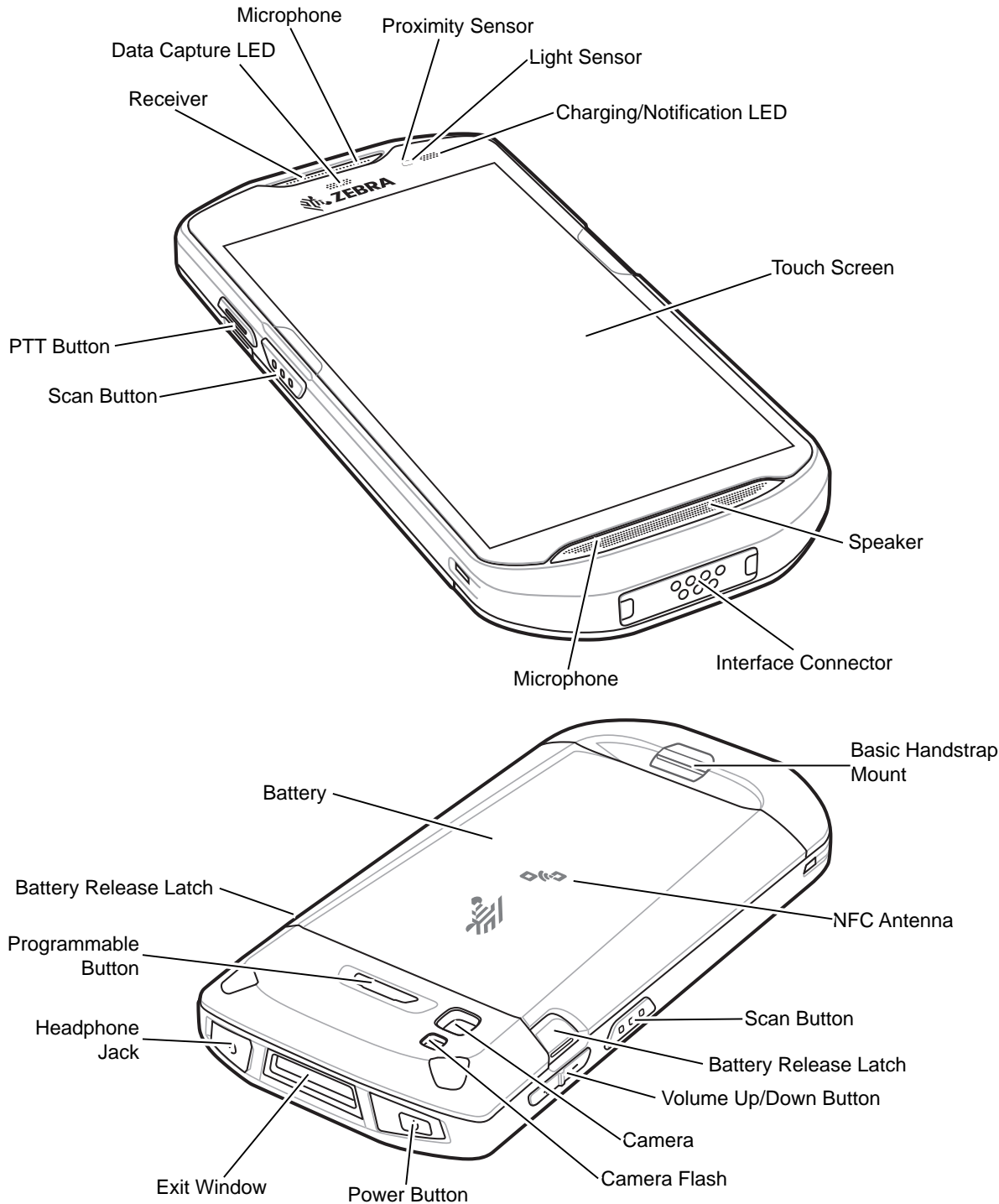

Installing a microSD Card

The microSD card slot provides secondary non-volatile storage. The slot is located under the battery pack. Refer to the documentation provided with the card for more information, and follow the manufacturer's recommendations for use.



CAUTION Follow proper electrostatic discharge (ESD) precautions to avoid damaging the microSD card. Proper ESD precautions include, but are not limited to, working on an ESD mat and ensuring that the operator is properly grounded.

1. Lift the access door.

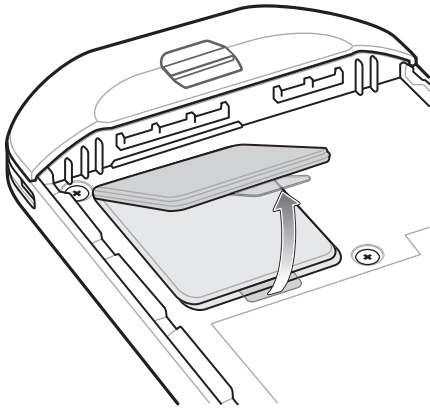

2. Slide the microSD card holder to the

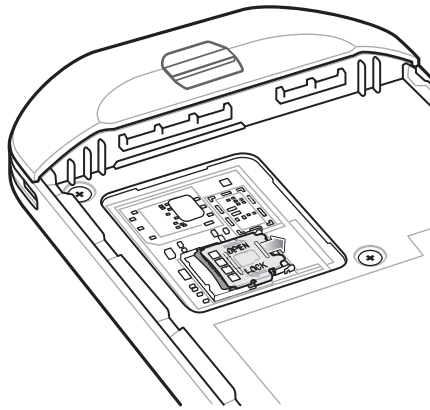

3. Lift the microSD card holder.

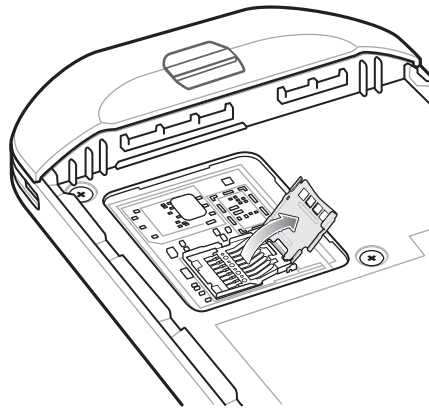

4. Insert the microSD card into the card holder door ensuring that the card slides into the holding tabs on each side of the door.

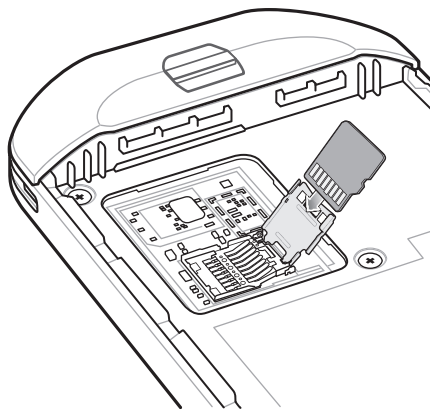

5. Close the microSD card holder and lock into position.

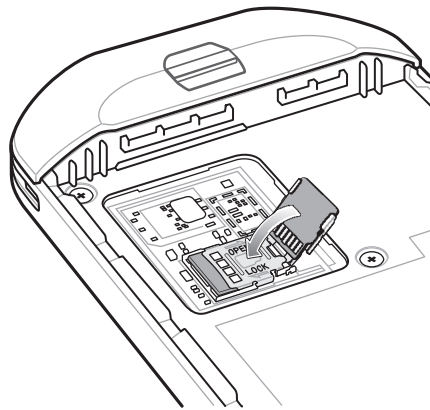

6. Re-install the access door.
-  **CAUTION** Access door must be replaced and securely seated to ensure proper device sealing.

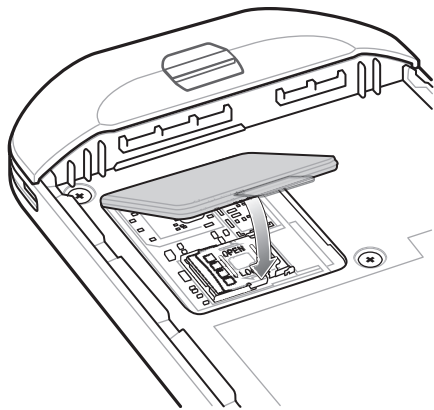

Installing the Battery

To install the battery:

1. Insert the silver end of the battery into the battery well.
2. Press the battery down until it snaps into place.

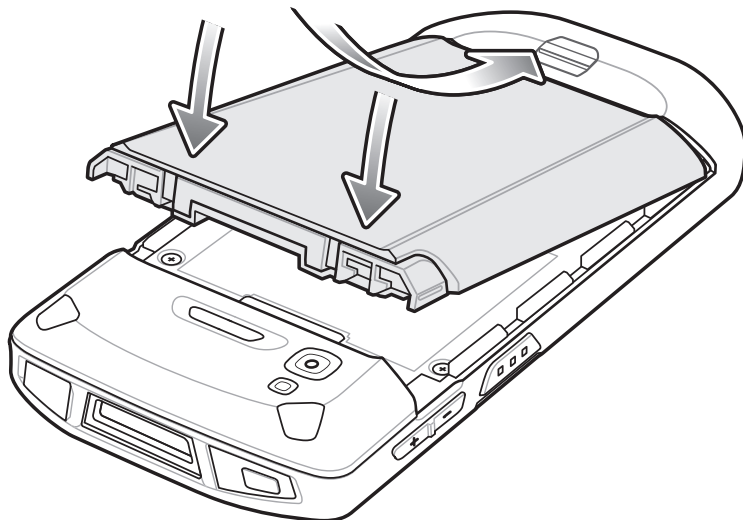

Charging the TC51

Use one of the following accessories to charge the TC51 and/or spare battery.

Table 1 *Charging and Communication*

Description	Part Number	Charging		Communication	
		Battery (In Device)	Spare Battery	USB	Ethernet
1-Slot USB/Charge Only Cradle Kit	CRD-TC51-1SCU-01	Yes	No	Yes	With Optional Module
5-Slot Charge Only Cradle Kit	CRD-TC51-5SCHG-01	Yes	No	No	No
4-Slot Charge Only Cradle with Battery Charger Kit	CRD-TC51-5SC4B-01	Yes	Yes	No	No
5-Slot Ethernet Cradle Kit	CRD-TC51-5SETH-01	Yes	Yes	No	Yes
4-Slot Battery Charger Kit	SAC-TC51-4SCHG-01	No	Yes	No	No
Rugged Charge/USB Cable	CBL-TC51-USB1-01	Yes	No	Yes	No

Charging the TC51

✓ **NOTE** Ensure that you follow the guidelines for battery safety described in the *TC51 User Guide*.

1. To charge the main battery, connect the charging accessory to the appropriate power source.
2. Insert the TC51 into a cradle or attach to a cable. The TC51 turns on and begins charging. The Charging/Notification LED blinks amber while charging, then turns solid green when fully charged.

The 4,300 mAh battery charges to 90% in less than 2.5 hours at room temperature.







Charging the Spare Battery

1. Insert a spare battery into the spare battery slot.
2. Ensure the battery is seated properly.

The Spare Battery Charging LED blinks indicating charging. See [Table 2](#) for charging indicators.

The 4,300 mAh battery charges to 90% in less than 2.5 hours at room temperature.

Table 1-1 Charging/Notification LED Charging Indicators

State	LED	Indication
Off		TC51 is not charging. TC51 is not inserted correctly in the cradle or connected to a power source. Charger/cradle is not powered.
Slow Blinking Amber (1 blink every 4 seconds)		TC51 is charging.
Slow Blinking Red (1 blink every 4 seconds)		TC51 is charging but the battery is at end of useful life.
Solid Green		Charging complete.
Solid Red		Charging complete but the battery is at end of useful life.
Fast Blinking Amber (2 blinks/second)		Charging error, e.g.: <ul style="list-style-type: none"> • Temperature is too low or too high. • Charging has gone on too long without completion (typically eight hours).
Fast Blinking Red (2 blinks/second)		Charging error but the battery is at end of useful life., e.g.: <ul style="list-style-type: none"> • Temperature is too low or too high. • Charging has gone on too long without completion (typically eight hours).

Charge batteries in temperatures from 0°C to 40°C (32°F to 104°F). The device or cradle always performs battery charging in a safe and intelligent manner. At higher temperatures (e.g. approximately +37°C (+98°F)) the device or cradle may for small periods of time alternately enable and disable battery charging to keep the battery at acceptable temperatures. The device and cradle indicates when charging is disabled due to abnormal temperatures via its LED.

1-Slot USB Charging Cradle

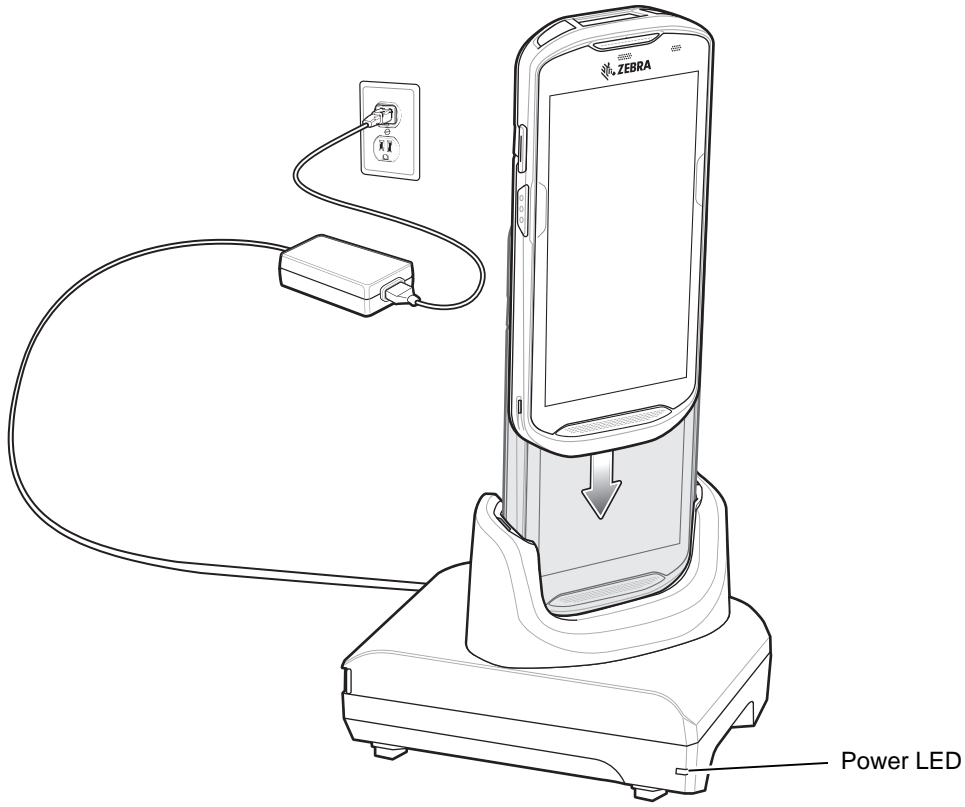

5-Slot Charge Only Cradle

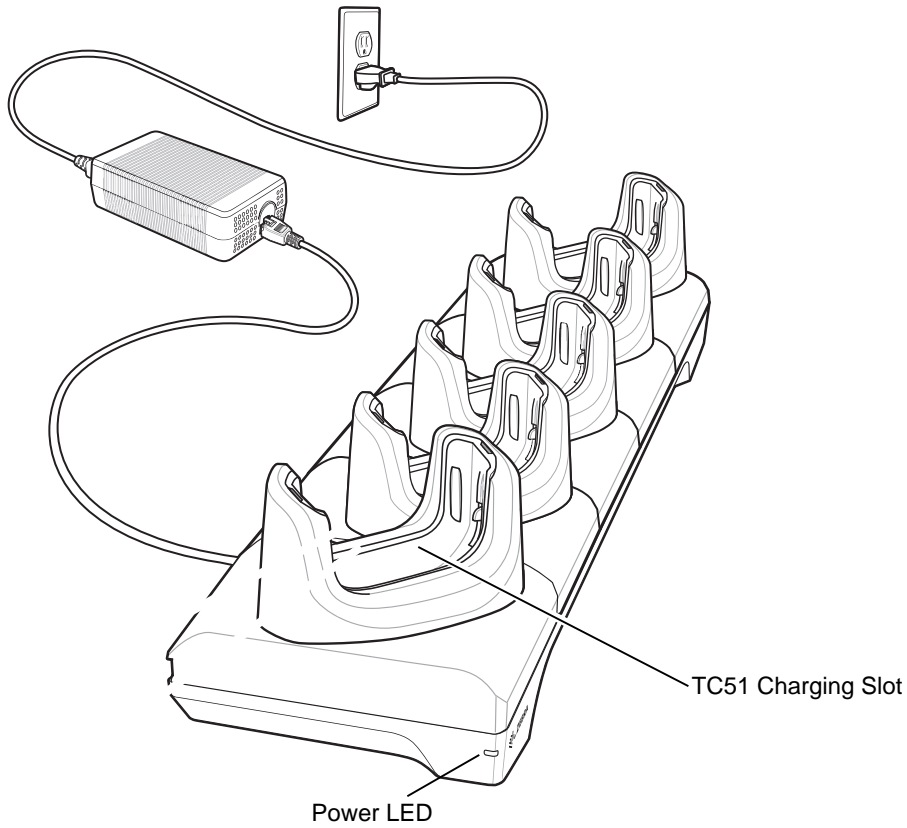

4-Slot Charge Only Cradle with Battery Charger

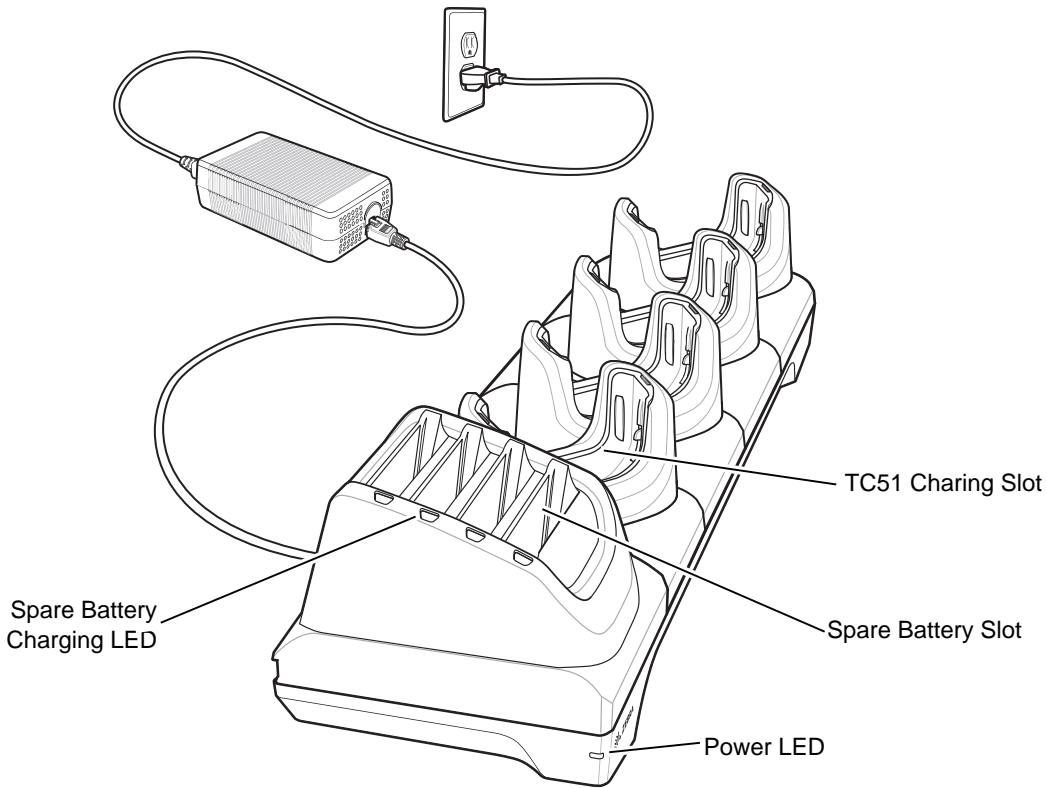

5-Slot Ethernet Cradle

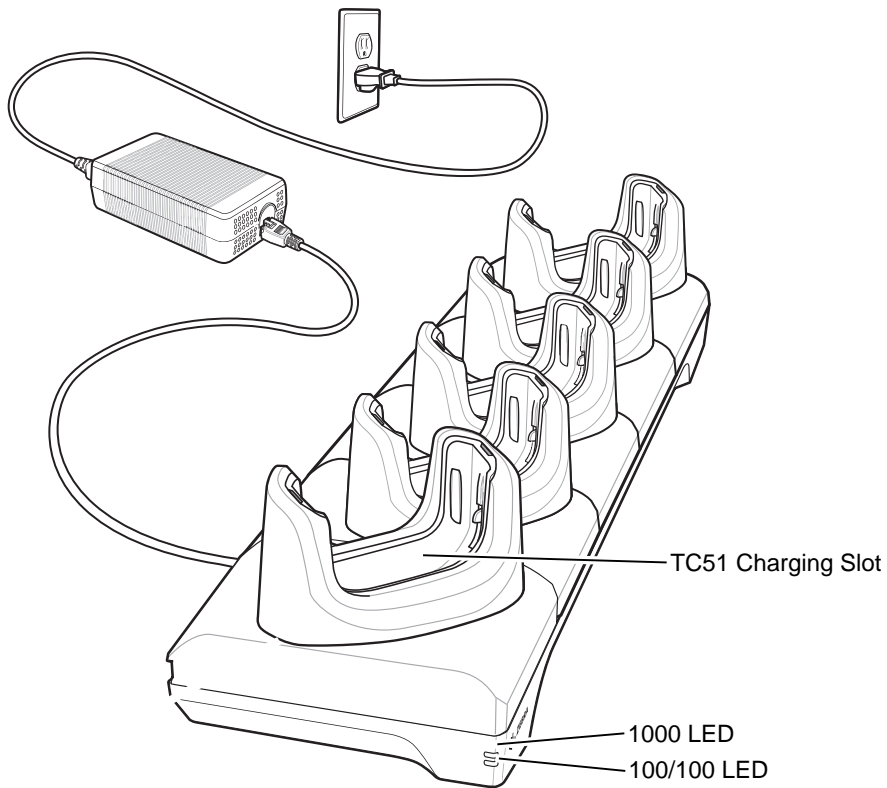

4-Slot Battery Charger

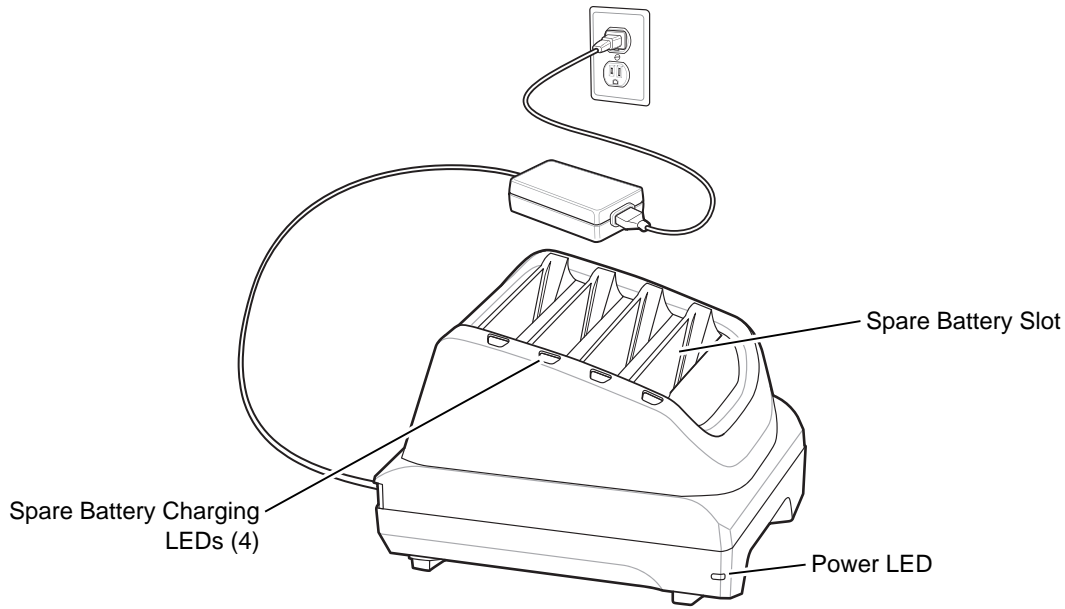

Rugged Charge/USB Cable

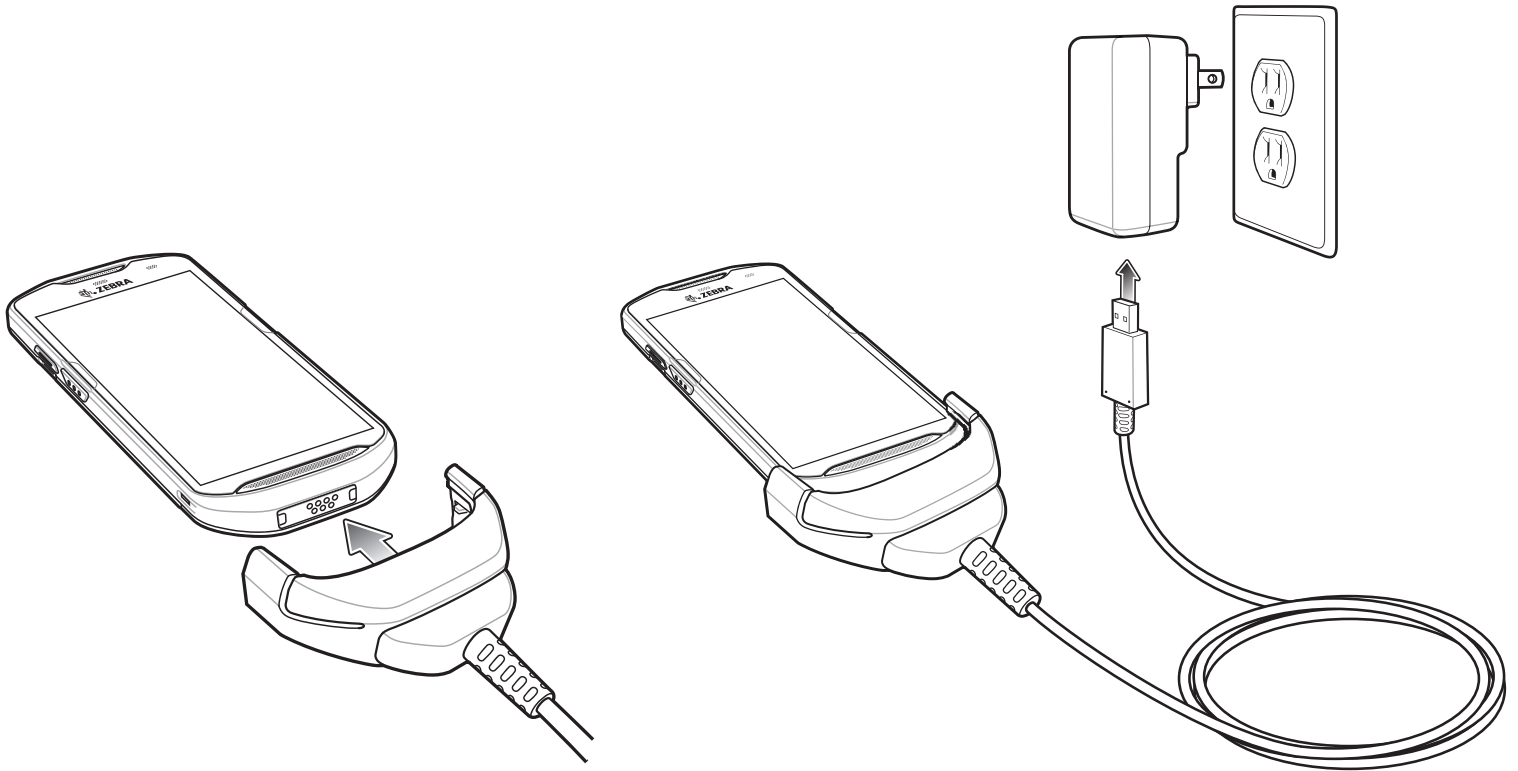

Scanning

To read a bar code, a scan-enabled application is required. The TC51 contains the DataWedge application that allows the user to enable the imager, decode the bar code data and display the bar code content.

1. Ensure that an application is open on the TC51 and a text field is in focus (text cursor in text field).
2. Point the exit window on the top of the TC51 at a bar code.

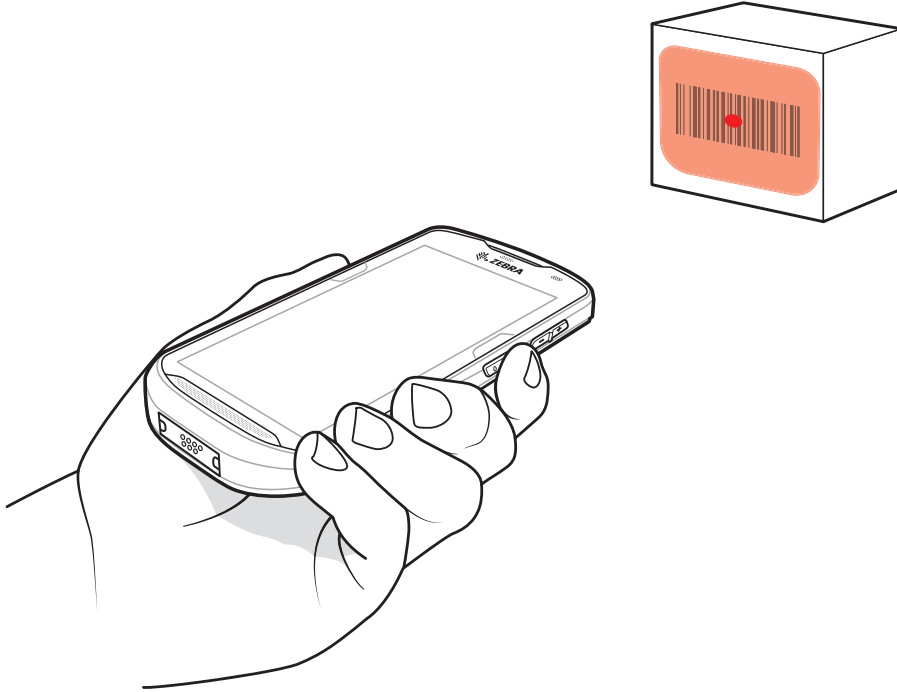

Figure 1 *Imager Scanning*

3. Press and hold the scan button.
The red laser aiming pattern turns on to assist in aiming.

✓ **NOTE** When the TC51 is in Picklist mode, the imager does not decode the bar code until the crosshair or aiming dot touches the bar code.

4. Ensure the bar code is within the area formed by the crosshairs in the aiming pattern. The aiming dot is used for increased visibility in bright lighting conditions.

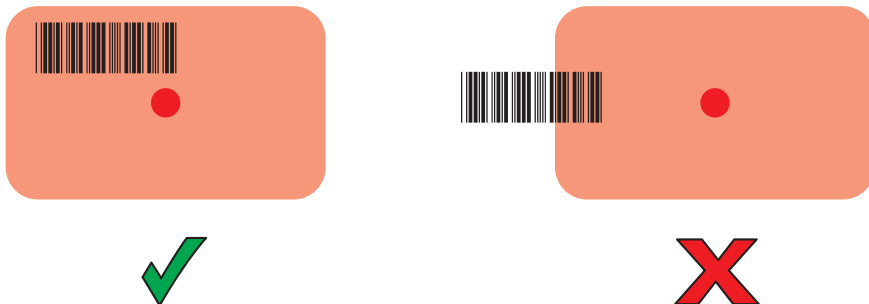

Figure 1-1 *Aiming Pattern*

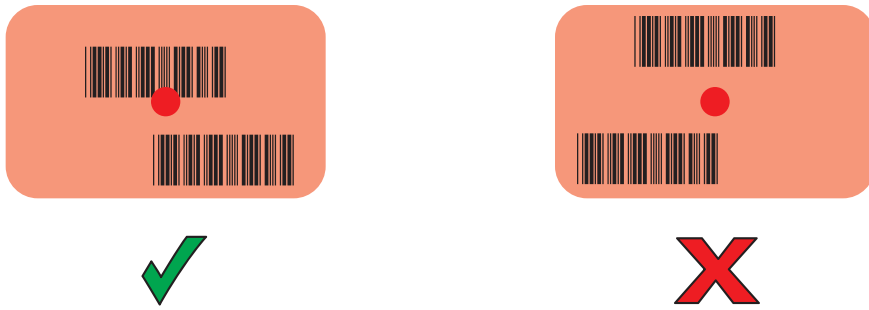

Figure 1-2 *Pick List Mode with Multiple Bar Codes in Aiming Pattern*

5. The Data Capture LED lights green and a beep sounds, by default, to indicate the bar code was decoded successfully.
6. Release the scan button.



NOTE Imager decoding usually occurs instantaneously. The TC51 repeats the steps required to take a digital picture (image) of a poor or difficult bar code as long as the scan button remains pressed.

7. The bar code content data displays in the text field.



Zebra Technologies Corporation

3 Overlook Point

Lincolnshire, Illinois 60069 USA

<http://www.zebra.com>

Zebra and the stylized Zebra head are trademarks of ZIH Corp., registered in many jurisdictions worldwide. All other trademarks are the property of their respective owners.

© 2016 Symbol Technologies LLC, a subsidiary of Zebra Technologies Corporation. All Rights Reserved.

